

Emerson[®]

***AM / FM CLOCK RADIO
with DUAL ALARMS
and NAP TIMER***



OWNER'S MANUAL

CK5048



Visit our web site at www.emersonradio.com





CAUTION

TO PREVENT FIRE OR SHOCK HAZARD, DO NOT USE THIS PLUG WITH AN EXTENSION CORD, RECEPTACLE OR OTHER OUTLET UNLESS THE BLADES CAN BE FULLY INSERTED TO PREVENT BLADE EXPOSURE. TO PREVENT FIRE OR SHOCK HAZARD, DO NOT EXPOSE THIS APPLIANCE TO RAIN OR MOISTURE.

 <p>The lightning flash with arrow-head symbol, within an equilateral triangle is intended to alert the user to the presence of uninsulated 'dangerous voltage' within the product's enclosure that may be of sufficient magnitude to constitute a risk of electric shock to persons.</p>	<p style="text-align: center;">CAUTION</p> <p style="text-align: center;">RISK OF ELECTRIC SHOCK DO NOT OPEN</p> <p>WARNING: TO REDUCE THE RISK OF ELECTRIC SHOCK DO NOT REMOVE COVER (OR BACK), NO USER SERVICEABLE PARTS INSIDE REFER SERVICING TO QUALIFIED SERVICE PERSONNEL.</p>	 <p>The exclamation point within an equilateral triangle is intended to alert the user to the presence of important operating and maintenance (servicing) instructions in the literature accompanying the appliance.</p>
--	---	---

IMPORTANT SAFETY INSTRUCTIONS

- 1.) Read these instructions.
- 2.) Keep these instructions.
- 3.) Heed all warnings.
- 4.) Follow all instructions.
- 5.) Do not use this apparatus near water.
- 6.) Clean only with dry cloth.
- 7.) Do not block any ventilation openings. Install in accordance with the manufacturer's instructions.
- 8.) Do not install near any heat sources such as radiators, heat registers, stoves, or other apparatus (including amplifiers) that produce heat.
- 9.) Do not defeat the safety purpose of the polarized or grounding-type plug. A polarized plug has two blades with one wider than the other. A grounding type plug has two blades and a third grounding prong. The wide blade or the third prong is provided for your safety. If the provided plug does not fit into your outlet, consult an electrician for replacement of the obsolete outlet.
- 10.) Protect the power cord from being walked on or pinched particularly at plugs, convenience receptacles, and the point where they exit from the apparatus.
- 11.) Only use attachments / accessories specified by the manufacturer.
- 12.) Unplug this apparatus during lightning storms or when unused for long periods of time.
- 13.) Refer all servicing to qualified service personnel. Servicing is required when the apparatus has been damaged in any way, such as power-supply cord or plug is damaged, liquid has been spilled or objects have fallen into the apparatus, the apparatus has been exposed to rain or moisture, does not operate normally, or has been dropped.
- 14.) This appliance shall not be exposed to dripping or splashing water and no object filled with liquids such as vases shall be placed on the apparatus.
- 15.) Do not overload wall outlet. Use only power source as indicated.
- 16.) Use replacement parts as specified by the manufacturer.
- 17.) The product may be mounted to a wall only if recommended by the manufacturer.
- 18.) Upon completion of any service or repairs to this product, ask the service technician to perform safety checks.



Thank you for purchasing this Emerson Compact AM/FM Clock Radio with Dual Alarms and NAP Timer.

The large LED display is designed to be highly visible and easily readable from anywhere in your room. The dual alarms can be set and used independently. And since there are two separate Radio/Buzzer selector switches, you can set one alarm to wake you to buzzer and the other to wake you to radio if you wish. All of the controls are easy to see and easy to use. The radio has a slide rule dial for easy tuning. The clock has forward and reverse setting controls for quick and easy adjustments.

The Sure-Alarm battery back up system will remember the time and alarm settings of course, but it can do more than that. As long as there is a fresh 9-volt battery installed, the Sure-Alarm system will operate the radio or buzzer alarm to wake you up even if the power is off at your normal wake up time.

We have taken great care to make sure that your radio was in perfect working order when it left our factory. It has been designed to give you many years of enjoyment and trouble free operation. Should you experience any problems with the operation or performance of this product please refer to the service and warranty information at the end of this instruction manual.

Once again, from all of us at Emerson Radio Corp., thanks for your purchase.

For future reference, record the serial number in the space provided.

Model: CK5048

Serial Number: _____



IMPORTANT NOTES

- Avoid installing this unit in places exposed to direct sunlight or close to heat radiating appliances such as electric heaters, on top of other stereo equipment that radiates too much heat, places lacking ventilation or dusty areas, places subject to constant vibration and/or humid or moist areas.
- Operate controls and switches as described in the manual.
- Before turning on the power, make certain that the power cord is properly installed.
- When moving the set, be sure to first disconnect the AC power cord.

FCC INFORMATION

This equipment has been tested and found to comply with the limits for a Class B digital device, pursuant to Part 15 of the FCC Rules. These limits are designed to provide reasonable protection against harmful interference in a residential installation. This equipment generates, uses, and can radiate radio frequency energy and, if not installed and used in accordance with the instructions, may cause harmful interference to radio communications. However, there is no guarantee that interference will not occur in a particular installation. If this equipment does cause harmful interference to radio or television reception, which can be determined by turning the equipment off and on, the user is encouraged to try to correct the interference by one or more of the following measures:

- Reorient or relocate the receiving antenna.
- Increase the separation between the equipment and receiver.
- Connect the equipment into an outlet on a circuit different from that to which the receiver is connected.
- Consult the dealer or an experienced radio/TV technician for help.

This device complies with Part 15 of the FCC Rules. Operation is subject to the following two conditions:

- (1) This device may not cause harmful interference, and
- (2) This device must accept any interference received, including interference that may cause undesired operation.

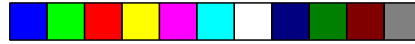

PREPARATION FOR USE

UNPACKING AND SET UP

- Remove the radio from the carton and remove all packing material from the radio. We suggest that you save the packing material, if possible, in the unlikely event that your radio ever needs to be returned for service. The original carton and packing material is the only safe way to pack your radio to protect it from damage in transit.
- Remove any descriptive labels or stickers on the front or top of the cabinet. Do not remove any labels or stickers from the back or bottom of the cabinet.
- Note the serial number on the bottom of your radio and write this number in the space provided on Page 2 of this manual.
- Place your radio on a level surface such as a table, desk or shelf, convenient to an AC outlet, out of direct sunlight, and away from sources of excess heat, dirt, dust, moisture, humidity, or vibration.
- Unwind the AC power cord and extend it to its full length. The FM antenna is built in to this cord. It must be fully extended to provide the best FM reception.

SURE-ALARM BATTERY BACK UP SYSTEM

The Sure-Alarm battery back up system in this radio will maintain the time and alarm settings in the event of a temporary power interruption. When the power is restored the time and alarm settings will be correct. If the power is off at your wake up time, the Sure-Alarm system will use the battery power to turn on the radio or buzzer alarm as usual, as long as the back up battery is installed and has sufficient power remaining.

The Sure-Alarm battery back up system requires one 9-volt battery, not included. We recommend that you install an alkaline battery for longest life and best performance.



TO INSTALL THE BATTERY

- Open the battery compartment cover on the bottom of the radio by sliding the cover in the direction of the arrow.

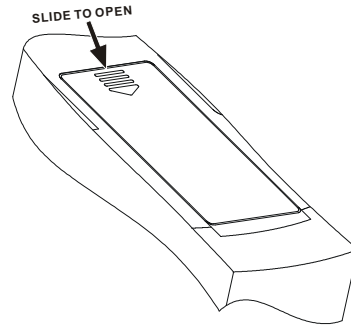

- Connect the 9-volt battery to the battery terminal. It can only be connected one way.

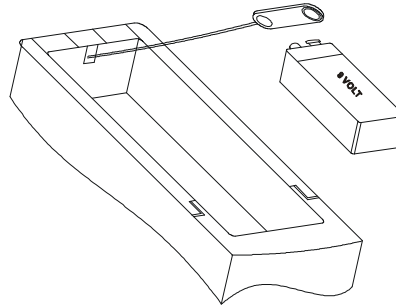

- Push the battery into the battery compartment and replace the cover.

POWER FAILURE INDICATOR

If no battery is installed in the radio, or if the battery in the compartment is weak or dead, the time and alarm settings will be lost if the power is interrupted. When the power is restored the clock display will begin flashing. This is your indication that the time display is incorrect and needs to be reset.

Important:

After you reset the time, be sure to reset your alarm settings as well.



POWER SOURCE

This radio is designed to operate on normal 120V 60Hz AC power only. Do not attempt to operate the radio on any other power source. You could cause damage to the radio that is not covered by your warranty.

This radio should be connected to an AC outlet that is always 'live'. Do not connect it to an outlet that is controlled by a wall switch. When the power to the radio is interrupted, the Sure Alarm battery back up system takes over to maintain the time and alarm settings. To maximize the life of the back up battery, keep the radio connected to a 'live' AC outlet at all times.

This radio uses a polarized AC plug which has one blade wider than the other. This plug will only fit into a polarized AC outlet. This is a safety feature. If the plug will not fit, you may have an older non-polarized AC outlet. Do not defeat the safety feature by trying to file the wider blade, or replacing the plug. Contact an electrician to replace your outdated outlet.

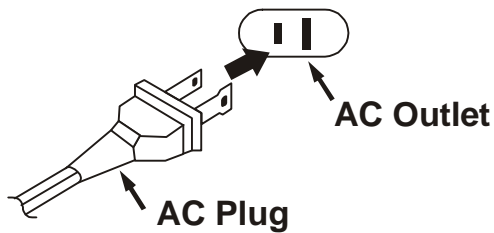



LOCATION OF CONTROLS AND INDICATORS

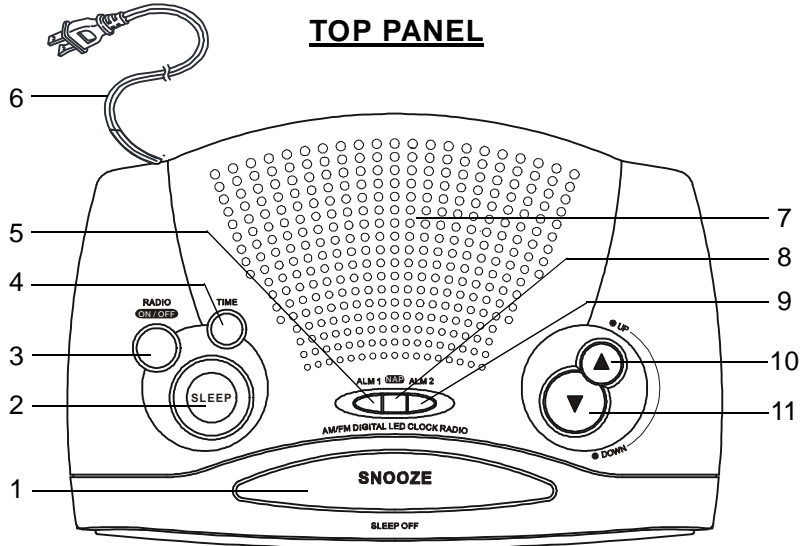

FRONT PANEL

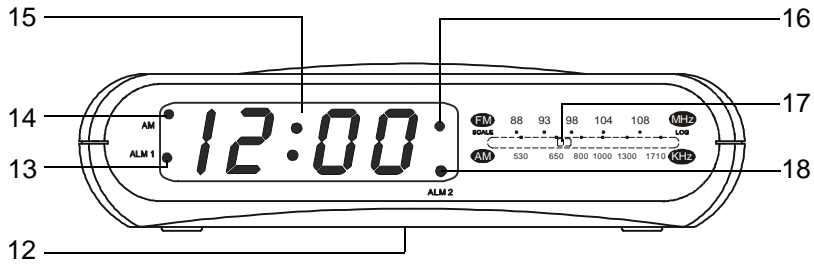

LEFT SIDE PANEL

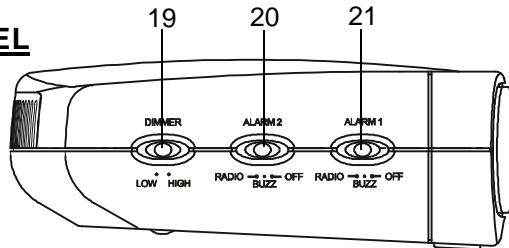

RIGHT SIDE PANEL

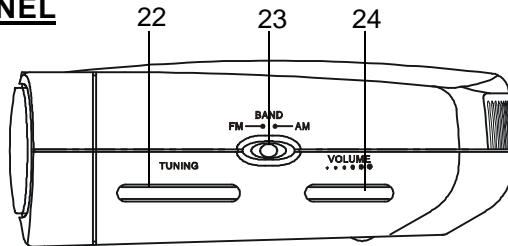



- 1.) **SNOOZE/SLEEP OFF**) Button.
- 2.) **SLEEP** Button.
- 3.) **RADIO ON/OFF** Button.
- 4.) **TIME** Setting Button.
- 5.) **ALM** (Alarm) **1** Setting/Reset Button.
- 6.) AC Power Cord.
- 7.) Speaker.
- 8.) **NAP** Button.
- 9.) **ALM** (Alarm) **2** Setting/Reset Button.
- 10.) Set **UP ▲** Button.
- 11.) Set **DOWN ▼** Button.
- 12.) Back Up Battery Compartment (Bottom Cabinet).
- 13.) **ALM** (Alarm) **1** 'On' Indicator.
- 14.) **AM** indicator.
- 15.) Time Display.
- 16.) **NAP** Indicator.
- 17.) Dial Pointer.
- 18.) **ALM** (Alarm) **2** 'On' Indicator.
- 19.) **DIMMER (LOW/HIGH)** switch.
- 20.) **ALARM 2 (RADIO/BUZZ/OFF)** Selector Switch.
- 21.) **ALARM 1 (RADIO/BUZZ/OFF)** Selector Switch.
- 22.) **TUNING** Control.
- 23.) **BAND (FM/AM)** Switch.
- 24.) **VOLUME** Control.



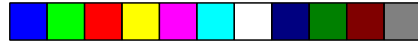

OPERATING INSTRUCTIONS

SETTING THE CLOCK

When you connect the radio to your AC outlet for the first time, the display will begin flashing "12:00" PM (Noon). The flashing will stop when you set the time.



- 1.) Press and release the **TIME** button. The display will stop flashing and you can now proceed to set the clock.
- 2.) Depress the TIME button together with either the **UP ▲** or **DOWN ▼** buttons **for at least two seconds** to move the display forward or backward to the correct time. The display will move rapidly forward or backward as long as the buttons are depressed.
- 3.) When the display approaches the correct time release the **UP ▲** or **DOWN ▼** buttons and then repeatedly press the **UP ▲** or **DOWN ▼** buttons to move display forward or backward, one minute at a time, until the correct time appears on the display.

AM indicator



Note: Observe the **AM** indicator to make sure you have set the clock to the correct hour, AM or PM. If the **AM** indicator is 'On' the time displayed is AM. If the **AM** indicator is 'Off' the time displayed is PM.



SETTING THE WAKE UP TIMES

This clock radio has two separate alarms that can be set and used independently. You may use the alarms to wake two people at different times, or you may use one alarm for weekdays and the other for weekend wake up times. The procedure for adjusting the wake up time is the same for both Alarm 1 and Alarm 2.

- 1.) Depress and hold either the **ALM 1** or **ALM 2** setting button. The display will change from the correct time to the Alarm 1 or Alarm 2 wake up time.
- 2.) While holding either the **ALM 1** or **ALM 2** setting button depress and hold either the **UP ▲** or **DOWN ▼** buttons **for at least two seconds** to move the display forward or backward to the correct wake up time. The display will move rapidly forward or backward as long as the buttons are depressed.
- 3.) When the display approaches the correct wake up time release the **UP ▲** or **DOWN ▼** buttons and then repeatedly press the **UP ▲** or **DOWN ▼** buttons to move display forward or backward, one minute at a time, until the correct wake up time appears on the display.

Note: Observe the **AM** indicator to make sure you have set the clock to the correct wake up hour, AM or PM. If the **AM** indicator is 'On' the time displayed is AM. If the **AM** indicator is 'Off' the time displayed is PM.

CHECKING THE WAKE UP TIMES

Whenever you want to check the wake up times, simply press either the **ALM 1** or **ALM 2** setting buttons. The display will change from correct time to wake up time. Release the **ALM 1** or **ALM 2** setting buttons to return to correct time.



LISTENING TO THE RADIO

Note: Set the clock before pressing the **RADIO ON/OFF** button to turn the radio 'On' for the first time.

- 1.) Set the **BAND** selector to the desired band, **AM** or **FM**.
- 2.) Set the **VOLUME** control to a low setting.
- 3.) Press the **RADIO ON/OFF** button to turn the radio 'On'.
- 4.) Select your desired station with the **TUNING** control.
- 5.) Adjust the **VOLUME** control to the desired setting.
- 6.) When you are finished listening, press the **RADIO ON/OFF** button to turn the radio 'Off'.

ANTENNA INFORMATION

AM

The AM bar antenna is inside the cabinet. If AM reception is weak, change the position of cabinet until the internal antenna picks up the strongest signal.

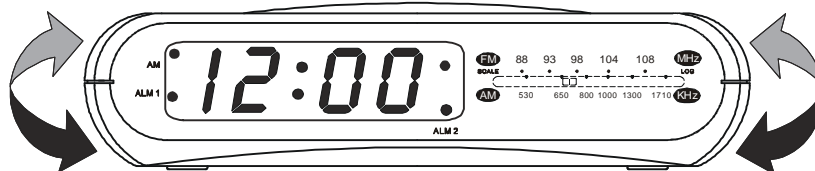

FM

The FM antenna is built in to the AC power cord. If FM reception is weak try varying the position and direction of the power cord until you find the strongest signal.



WAKE TO RADIO

- 1.) Turn the radio 'On' and select the band, station, and volume level that you wish to hear when the alarm comes on, then turn the radio 'Off' again.
- 2.) Reconfirm the wake up time settings for the alarm you are using, Alarm 1, Alarm 2, or both alarms.
- 3.) Set the **ALARM** selector switch for one or both alarms to the '**RADIO**' position. The appropriate **ALM 1** and/or **ALM 2** indicators will light up to confirm that the alarms are set.



- 4.) At the selected wake up time the radio will turn 'On'. It will play for one hour and then shut off automatically.
- 5.) To stop the radio sooner, press the **RADIO ON/OFF** button. The radio will stop but the alarm remains set and will turn the radio on again at the same time on the following day.
- 6.) If you do not want the alarm to turn the radio on the following day, set the appropriate **ALARM** selector to the '**OFF**' position.

WAKE TO BUZZER

- 1.) Reconfirm the wake up time settings for the alarm you are using, Alarm 1, Alarm 2, or both alarms.
- 2.) Set the **ALARM** selector switch for one or both alarms to the '**BUZZ**' position. The appropriate **ALM 1** and/or **ALM 2** indicators will light up to confirm that the alarms are set.
- 3.) At the selected wake up time the buzzer will sound. It will continue for one hour and then shut off automatically.
- 4.) To stop the buzzer sooner, press the **RADIO ON/OFF** button. The buzzer will stop but the alarm remains set and will turn the buzzer on again at the same time on the following day.
- 5.) If you do not want the alarm to turn the buzzer on the following day, set the appropriate **ALARM** selector to the '**OFF**' position.



RADIO AND BUZZER OPERATION

You may also set one alarm for wake to radio and the other for wake to buzzer. Just set the **ALARM 1** and **ALARM 2** selector switches to the desired positions.

SNOOZE ALARM

After the radio or buzzer alarm sounds in the morning you may press the **SNOOZE** Bar for a few more minutes sleep. The alarm will stop for approximately 9 minutes and then turn on again.

Note: *Whenever the **SNOOZE** Bar is depressed the display changes from normal time to a “minutes and seconds” display. The minute will be the last digit that appeared in the time display, and the seconds will continue to advance. When the **SNOOZE** bar is released the display returns to the correct time.*



NAP TIMER

This radio includes a programmable Nap Timer alarm. Use the Nap Timer to wake up after a nap without disturbing your regular alarm settings. The Nap Timer can be used for naps of up to 99 minutes.

To set the Nap Timer:

- 1.) Depress the **NAP** button. The display will show “n 30”, indicating a 30 minute nap time, and the **NAP** indicator will light. After 30 minutes the buzzer alarm will turn on.



- 2.) To adjust the length of the Nap Timer depress and hold the **NAP** button, and repeatedly press either the **UP ▲** or **DOWN ▼** buttons until the display shows the desired Nap time. You can select between 1 minute and 99 minutes.

Note: When you change the length of the Nap Timer setting, the new setting becomes the default setting.

For example if you change the Nap Timer from 30 minutes to 45 minutes, the new default setting will become 45 minutes. The next time you press the **NAP** button the Nap Timer will start at 45 minutes. However if the power is interrupted and the back up battery is not installed, the Nap Timer will return to the original 30-minute default setting.

- 3.) When the Nap Timer counts down to “00” the buzzer alarm will turn on. Press the **SNOOZE** button to shut off the buzzer alarm.

Note: If you do not press the **SNOOZE** button to shut the buzzer off, it will continue for one hour and then shut off automatically.

To cancel the Nap Timer before the buzzer alarm turns on, press the **SNOOZE** button at any time. The **NAP** indicator goes off and the buzzer alarm will not turn on.

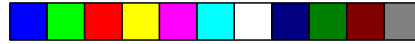

SLEEP TO MUSIC TIMER

You can program the Sleep Timer to play the radio for up to 99 minutes and then shut off automatically.

- 1.) Depress the **SLEEP** button. The display will show “L 30”, the radio will turn on, play for 30 minutes and then turn off automatically.



- 2.) To adjust the length of the Sleep Timer depress and hold the **SLEEP** button, and repeatedly press either the **UP ▲** or **DOWN ▼** buttons until the display shows the desired Sleep time. You can select between 1 minute and 99 minutes.

Note: When you change the length of the Sleep Timer setting, the new setting becomes the default setting.

*For example, if you change the Sleep Timer from 30 minutes to 45 minutes, the default setting will become 45 minutes. The next time you press the **SLEEP** button the Sleep Timer will start at 45 minutes. However, if the power is interrupted and the back up battery is not installed, the Sleep Timer will return to the original 30-minute default setting.*

- 3.) When the Sleep Timer counts down to “00” the radio will shut off automatically.

To cancel the Sleep Timer operation and shut the radio off before the Sleep Timer counts down to “00”, press the **SNOOZE** button at any time.

IMPORTANT: Remember that the radio station and volume settings that you choose for Sleep To Music operation are the same settings you will hear if you set the alarm for Wake To Radio the following morning.

DIMMER CONTROL

The **DIMMER** control was set to the ‘**HIGH**’ position at our factory. If you find the clock display is too bright in a darkened room, set the Dimmer control to the ‘**LOW**’ position.

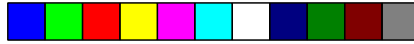

CARE AND MAINTENANCE

There are no user serviceable parts inside this radio. Please refer all service problems to a qualified service facility. See the warranty page of this manual for further details.

If the cabinet becomes dusty, wipe the exterior with a soft dust cloth only. Never use dusting sprays or polishes on the cabinet.

If the cabinet becomes dirty or smudged with fingerprints it may be wiped with a soft cloth that has been slightly dampened with a mild soap and water solution. Always disconnect the power cord from the AC outlet before cleaning, and never allow any liquid to get inside the cabinet.

Note: *If there is no battery in the back-up battery compartment, the Time and Alarm settings will be lost when the power cord is disconnected for cleaning. Reset the clock and wake up times after reconnecting the power cord.*



TO FIND THE LOCATION AND PHONE NUMBER
OF YOUR NEAREST SERVICE CENTER
PERMITTED TO PERFORM WARRANTY...

CALL TOLL FREE: 1-800-695-0098

FOR ADDITIONAL SET-UP OR OPERATING ASSISTANCE
PLEASE CALL:
1-800-898-9020

FOR CUSTOMER SERVICE, PLEASE WRITE TO:
Emerson Radio Corp.
Consumer Affairs Dept.
1901 Diplomat Drive,
Farmers Branch, TX 75234.



LIMITED WARRANTY

Emerson Radio Corp. warrants manufacturing defects in original material, including original parts and workmanship, under normal use and conditions, for a period of ninety (90) days from the date of original purchase in the U.S. With your dated proof of purchase, we will provide repair service at no charge for labor and parts at an authorized Depot Repair Facility, or replace the product in our discretion. For repair or replacement, pack your unit in a padded box, enclose your check or money order payable to Emerson Radio Corp. in the amount of \$5.00 (not required by California residents) to cover shipping and handling costs, and enclose a copy of your proof of purchase. Send your unit to:

Emerson Radio Corp.
1901 Diplomat Drive,
Farmers Branch, TX 75234.

This warranty does not cover damage from negligence, misuse, abuse, accident, failure to follow operating instructions, commercial use, rental, repairs by an unauthorized facility, or products purchased, used, serviced or damaged outside of the United States.

THIS WARRANTY GIVES YOU SPECIFIC LEGAL RIGHTS, AND YOU MAY ALSO HAVE OTHER RIGHTS WHICH VARY FROM STATE TO STATE.

AU898H



EMERSON
Part No. : 16-2945
403-01

Printed in China